



Bambu Lab X1E

Empower Brilliant Minds
To Craft The Future



ABOUT US

Bambu Lab is a consumer tech company focusing on desktop 3D printers. Its state-of-the-art 3D printers offer a feature-rich first-class experience for a global community of 3D printing makers, aiming to break the barriers between the digital and physical worlds and bring creativity to a whole new level. Bambu Lab sells its 3D printers, filaments, and accessories on its official website, serving customers across 30+ countries.

OUR TEAM

Our story started with the gathering of a team of 3D printing fans, who are also expert engineers in robotics, artificial intelligence, materials science, and internet industries. Our team is experienced in building high-tech products that bring positive impacts to the world. From the start, we have been dedicated to making cutting-edge technology affordable with advanced know-how and high production quality. We see ourselves as part of the ecosystem and are delighted to learn from and share knowledge with the 3D printing community. Our team's passion lies also in the commitment to creating the next generation of eco-friendly 3D printers - pushing the industry toward a future with a much lower carbon-footprint.



Enhanced And More Connection Options

The X1E offers the option to connect to your devices through its newly added Ethernet port, ensuring robust network communication in complex environments. Ethernet connectivity can also be used in crowded wireless signal environments. Additionally, the X1E provides WPA2-Enterprise Wi-Fi Authentication (EAP-PEAP/EAP-TLS/TAP-TTLS) and individual physical kill switches for both Wi-Fi and Ethernet, meeting stringent network security requirements.

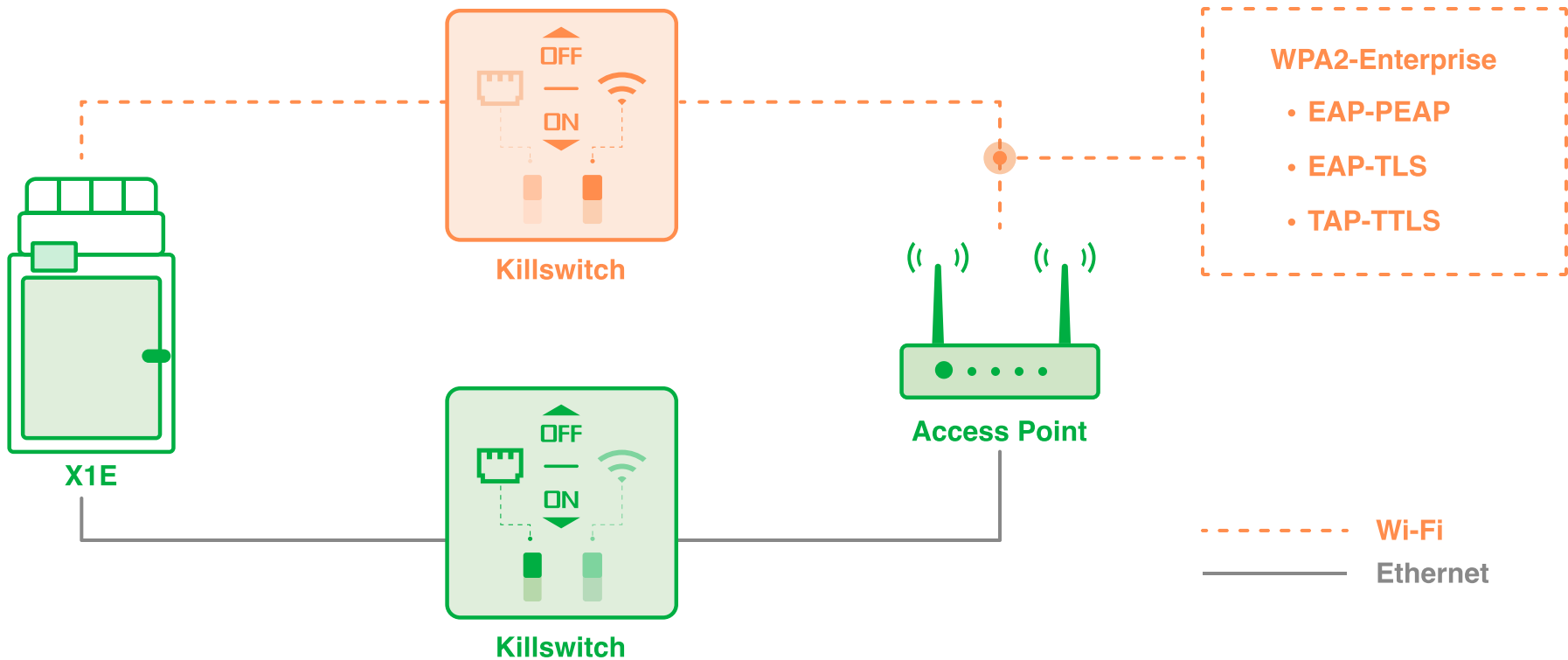

Off-Cloud Operation

The X1E can operate independently without a connection to Bambu Cloud Service, fully functional within your local network. Customers can remotely control the X1E through LAN communication without requiring an Internet connection. For additional developer details, please contact your regional reseller.

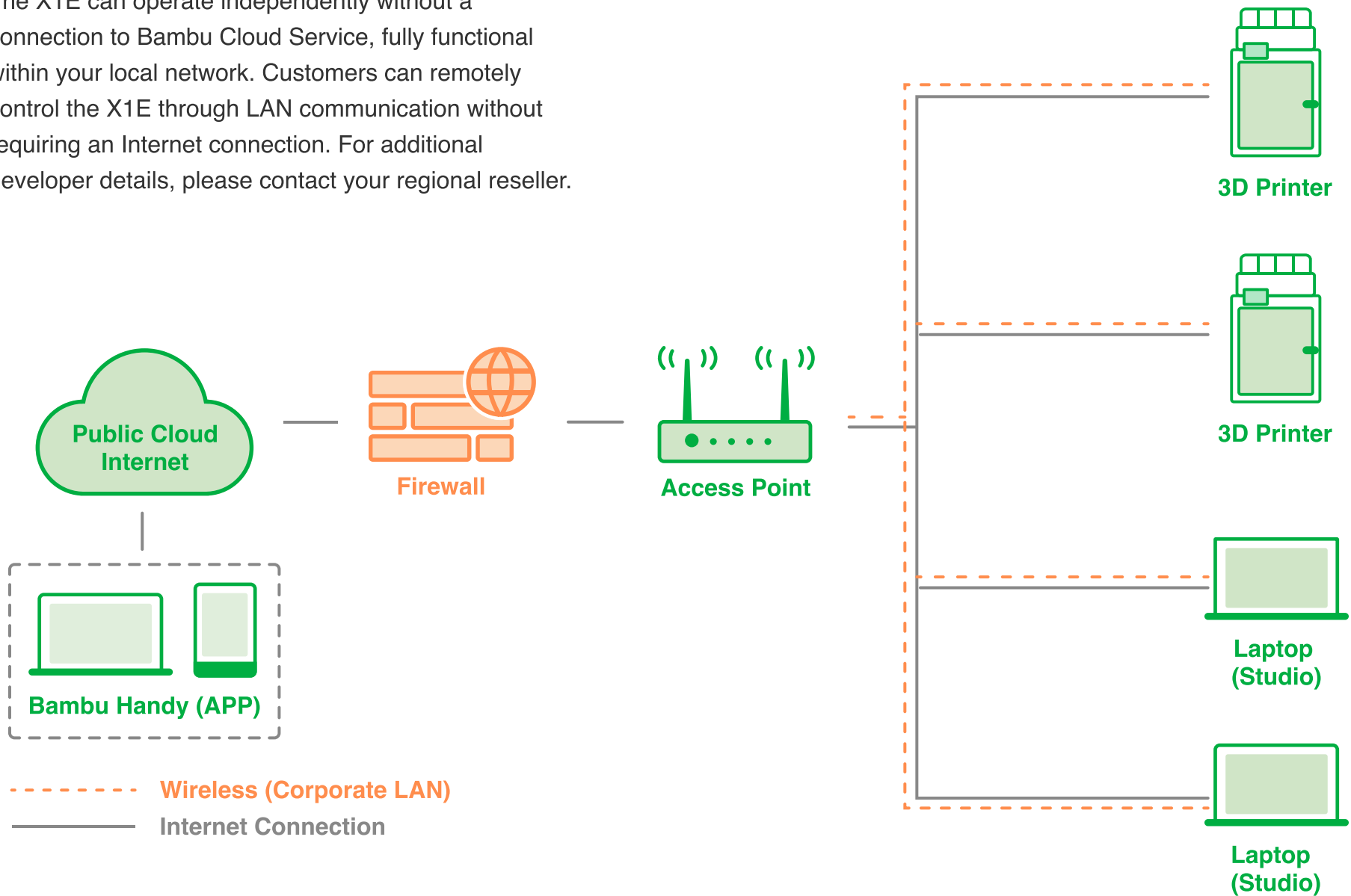

Heavy Duty Air Filtration

We combined a G3 pre-filter, an H12 HEPA filter, and a high-quality coconut shell activated carbon filter to provide optimal air filtration. Enhanced filtration can effectively reduce excessive odors and harmful particulates when printing in less ventilated environments.

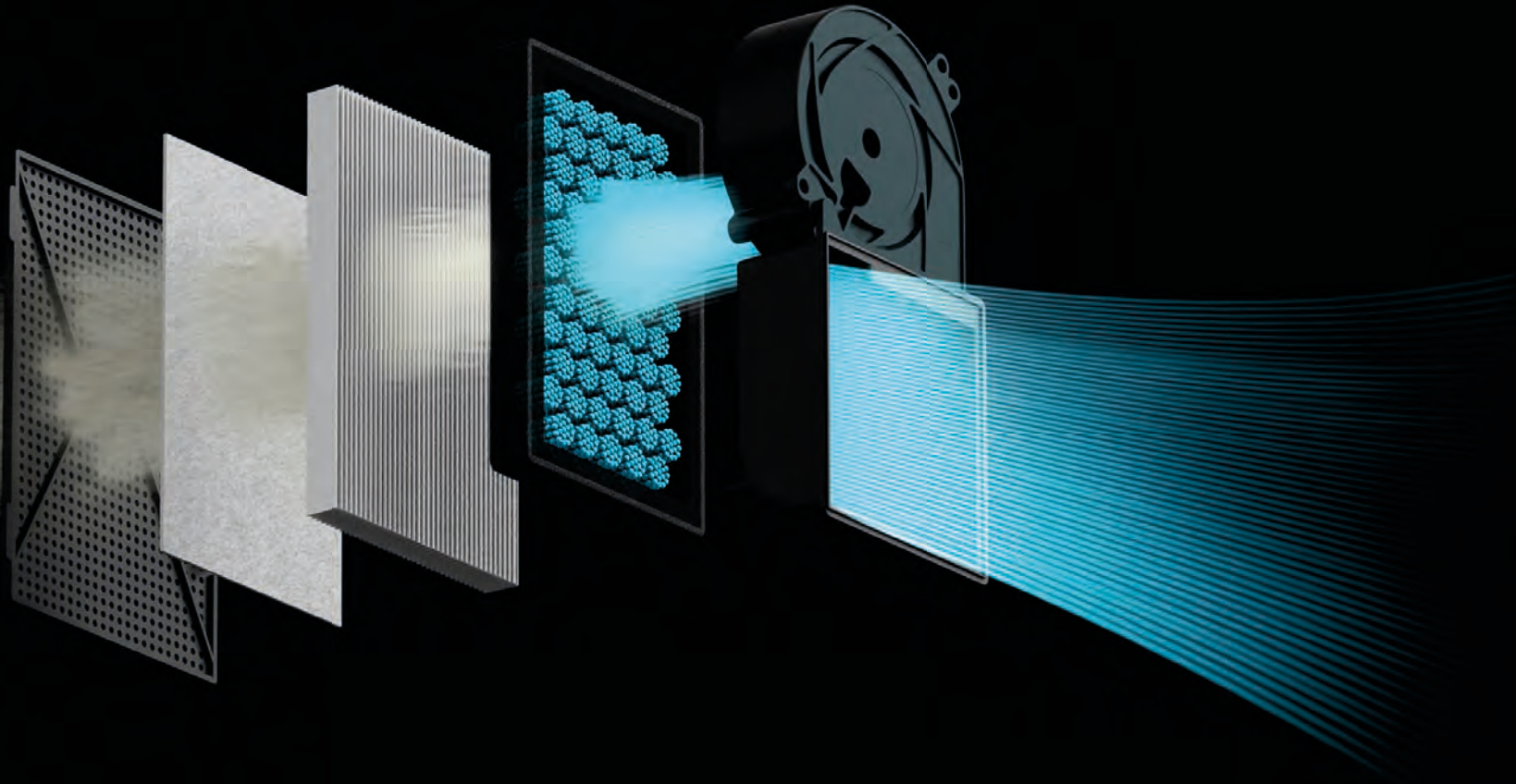

Active Heating And Controlled Chamber Temp

The X1E can actively heat and regulate the chamber temperature. Accurately controlled chamber temperature (up to 60°C or 140°F) improves print quality, especially for filaments prone to warping such as ABS and PC.

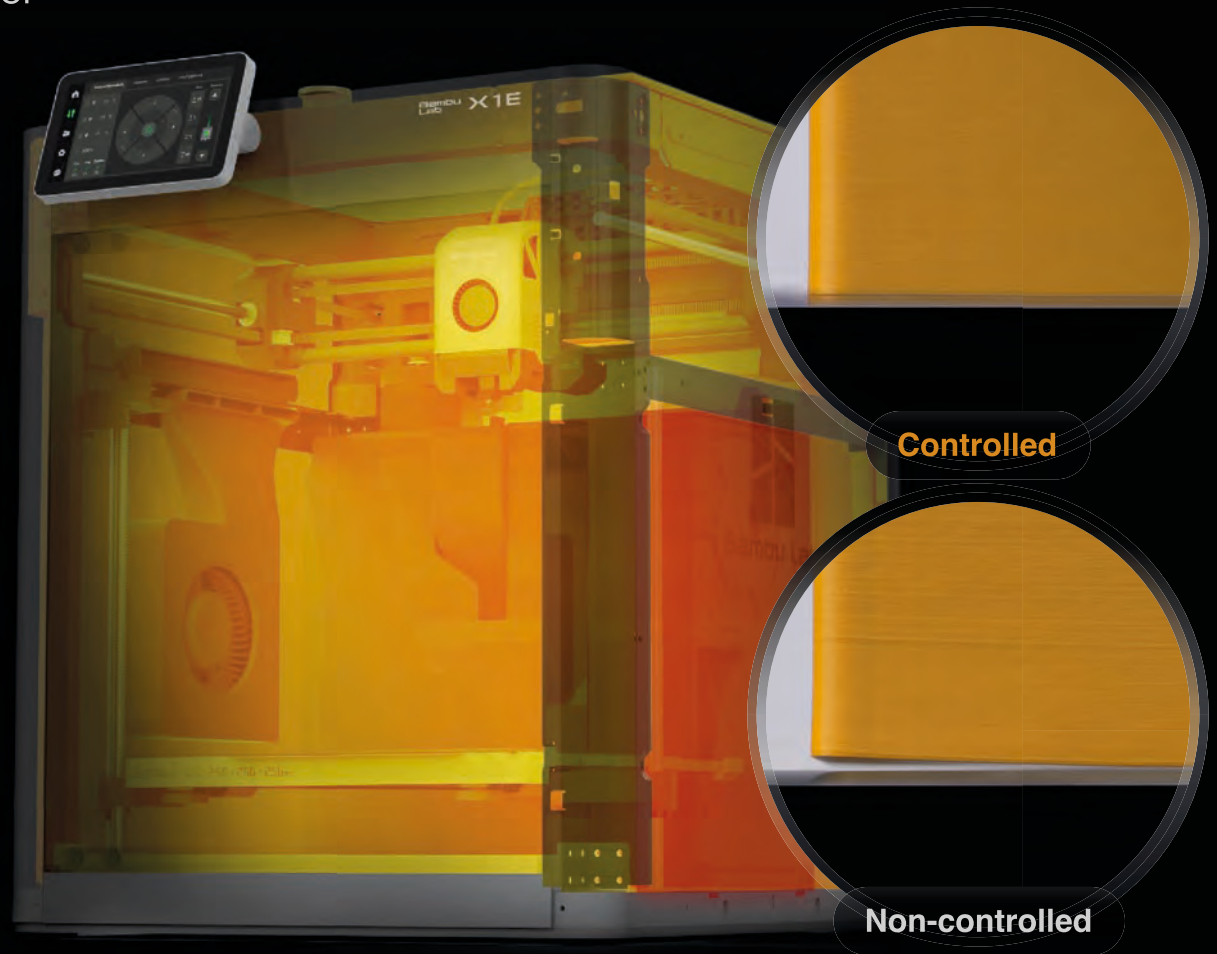

320°C (608°F) Nozzle Temp

Higher nozzle temperature make possible to print higher performance materials such as PPA-CF/GF PPS and PPS-CF. These new materials have better dimensional stability, heat resistance and mechanical performance.



Robust High Speed CoreXY

The superior carbon-fiber rods in the CoreXY motion structure enable the X1E to achieve a toolhead acceleration of 20,000 mm/s² by reducing the weight of moving parts. This faster acceleration allows the X1E to maintain its maximum travel speed of 500 mm/s for longer periods, significantly reducing overall print time.

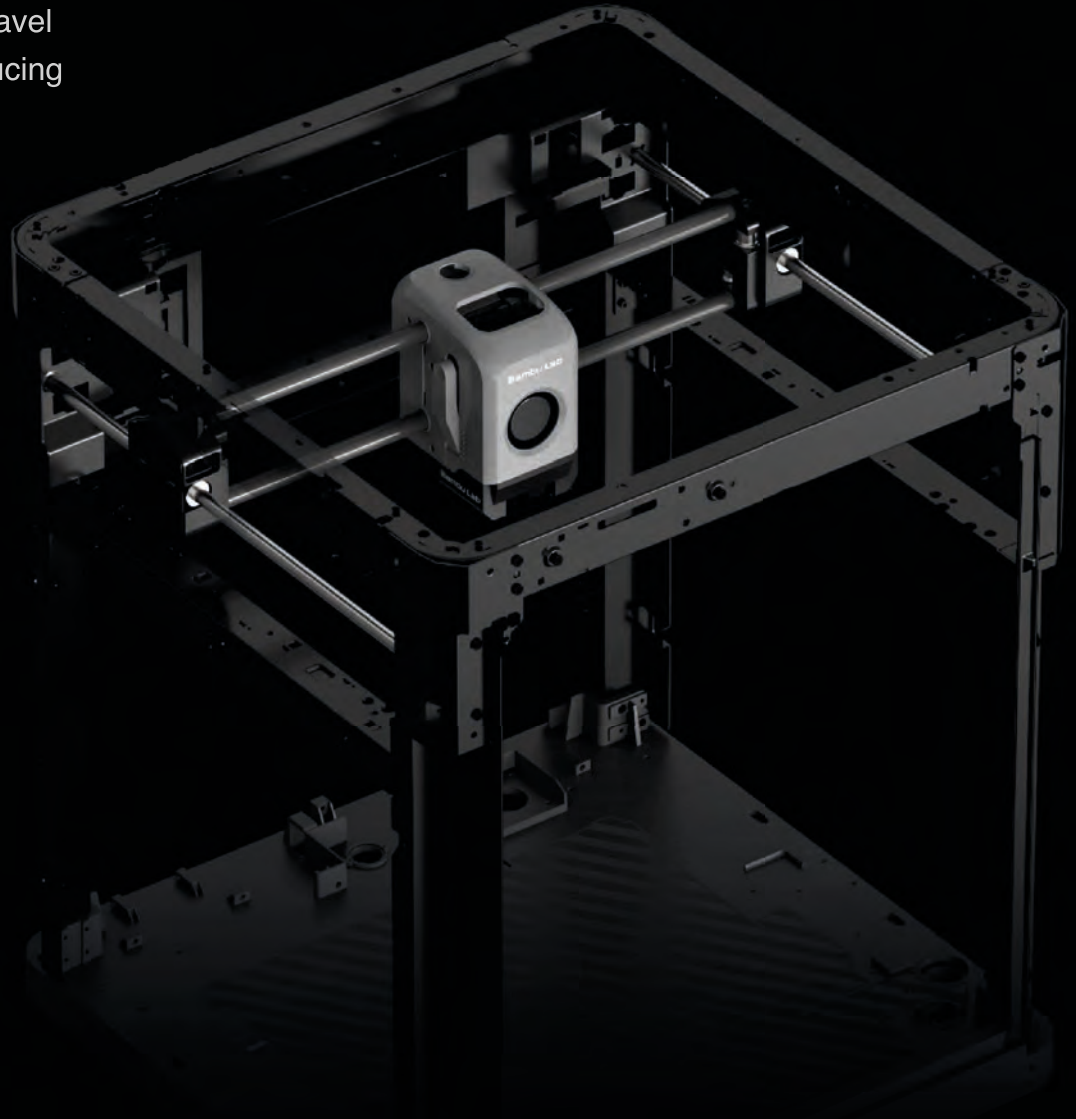

Vibration And Extrusion Compensation

X1E can actively compensate for XY-axis vibrations and extrusion issues to ensure exceptionally smooth print quality. All measurements are fully automatic, eliminating the need for manual adjustments.



Active Vibration Compensation: ON



Active Vibration Compensation: OFF

AI Failure Detection

The X1E's AI algorithm can detect first-layer imperfections and spaghetti failures with the assistance of Lidar and computer vision. It then automatically pauses the print to prevent catastrophic failures.

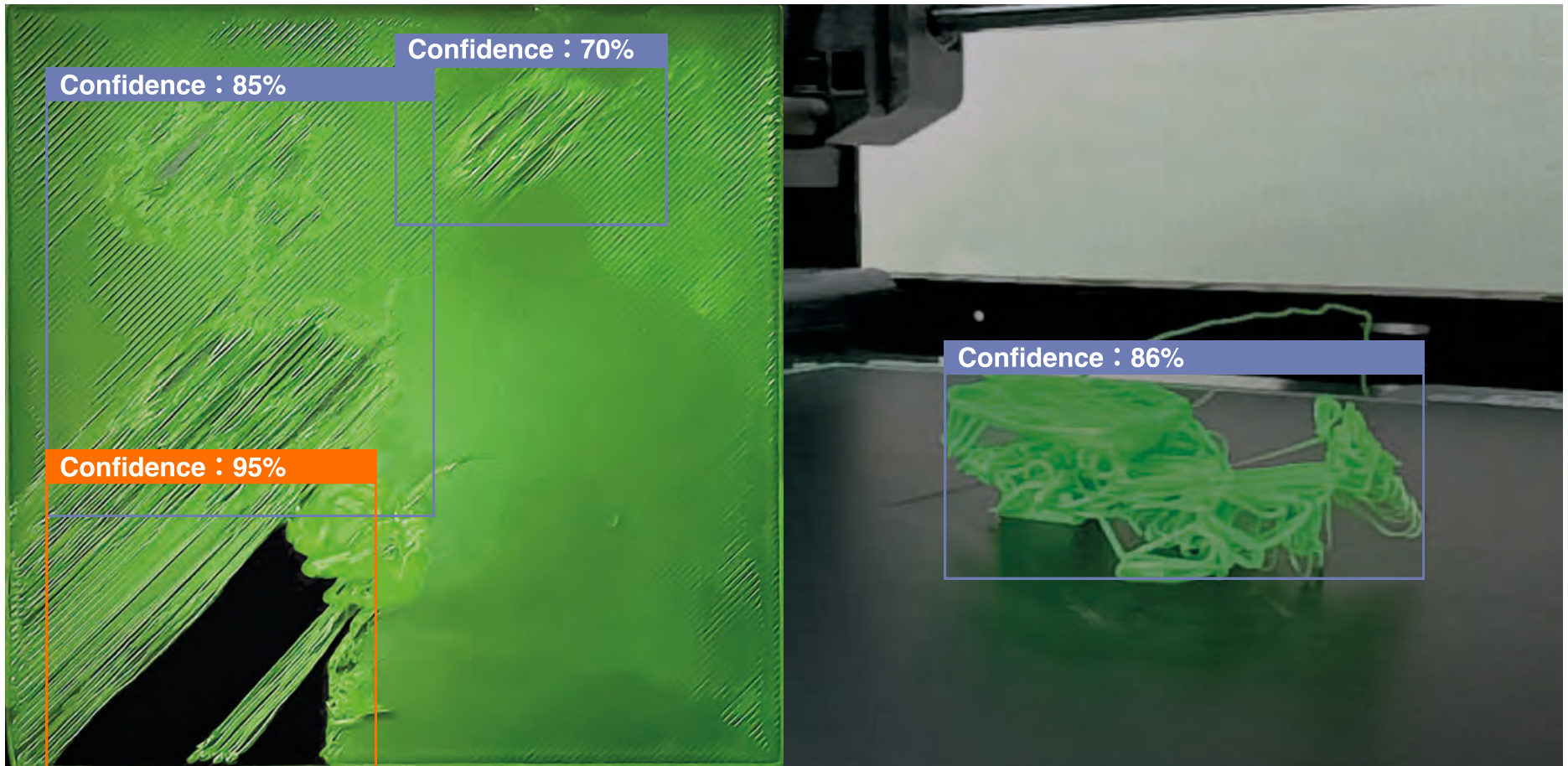

Intelligent Filament Management

X1E can parallel connect 4 Bambu AMS systems to print with up to 16 spools of filaments, good for printing dedicated support materials for seamless surface and printing multi-color. The AMS system also supports automatic filaments reload, fully used up all filament on one spool before switching to the next.

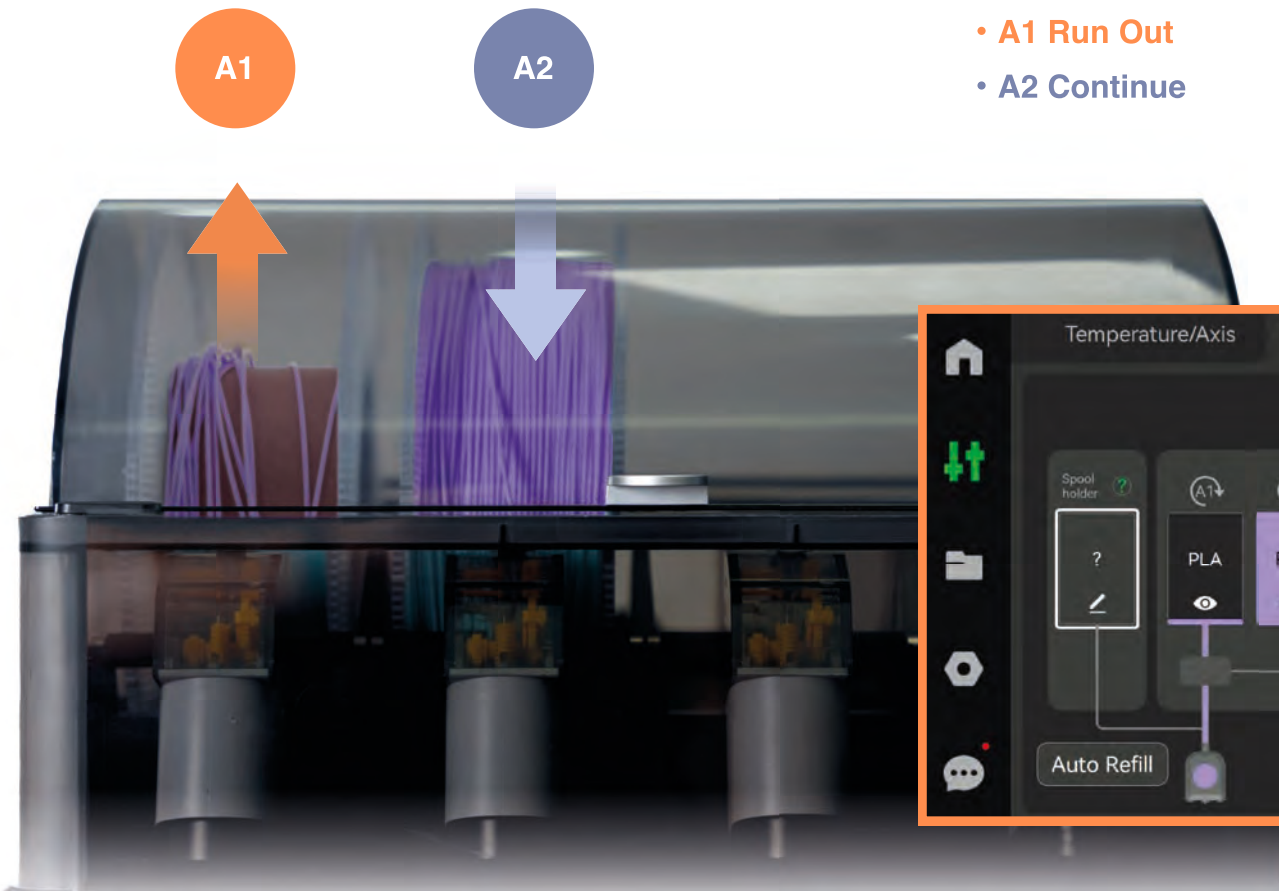

- A1 Run Out
- A2 Continue

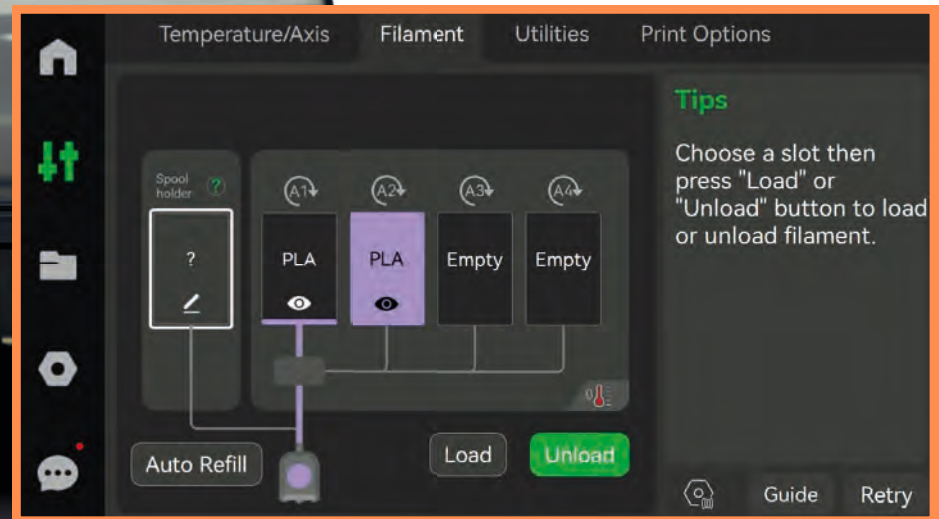

Technical Specification

Body

Build Volume:	256*256*256 mm ³
Chassis:	Steel
Shell:	Aluminum & Glass

Supported Filament

PLA, PETG, TPU, PVA, BVOH:	Optimal
ABS, ASA, PC, PA, PET:	Superior
Carbon/Glass Fiber Reinforced PLA, PETG, PA, PET, PC, ABS, ASA:	Superior
PPA-CF/GF, PPS, PPS-CF/GF:	Ideal

Heating

Active Chamber Heating:	yes
Maximum Chamber Control Temperature:	60 °C

Air Purification

Pre-filter grade:	G3
HEPA filter grade:	H12
Activated Carbon Filter type:	Coconut Shell Granulated
VOC Filtration:	Optimal
Particulate Matter Filtration:	Yes

Cooling

Part Cooling Fan:	Closed Loop Control
Hot End Fan:	Closed Loop Control
Control Board Fan:	Closed Loop Control
Chamber Temperature Regulator Fan:	Closed Loop Control
Auxiliary Part Cooling Fan:	Closed Loop Control

ToolHead

Hot End:	All-Metal
Extruder Gears:	Hardened Steel
Nozzle:	Hardened Steel
Max Hot End Temperature:	320 °C
Nozzle Diameter (Included):	0.4 mm
Nozzle Diameter (Optional):	0.2 mm, 0.6 mm, 0.8 mm

Heatbed

Build Plate :	Bambu High Temperature Plate, Bambu Textured PEI Plate, Bambu Cool Plate
---------------	---

Speed

Max Speed of Toolhead:	500 mm/s
Max Acceleration of Toolhead:	20 m/s ²
Max Hot End Flow:	32 mm ³ /s @ABS(Model: 150*150mm single wall; Material: Bambu ABS; Temperature: 280°C)

Sensors

Bambu Micro Lidar:	Yes
Chamber Monitoring Camera:	1920*1080 Included
Door Sensor:	Yes
Filament Run Out Sensor:	Yes
Power Loss Recover:	Yes

Physical Dimensions

Dimensions:	389*389*457 mm ³
Net Weight :	16 kg

Electrical Requirements

Voltage:	100-240 VAC, 50/60 Hz
Max Power:	1400W@220V, 750W@110V

Electronics

Display:	5-inch 1280*720 Touch Screen
Storage:	4GB EMMC and Micro SD Card Reader
Control Interface:	Touch Screen, APP, PC Application
Motion Controller:	Dual-Core Cortex M4
Application Processor:	Quad ARM A7 1.2 GHz
Neural-Network Processing Unit:	2 Tops

Network Control

Ethernet:	Yes
Wireless Network:	Wi-Fi
Network Kill Switch:	Wi-Fi & Ethernet
Removable Network Module:	Yes

Wi-Fi

Frequency Range:	2412 MHz - 2472 MHz (CE) 2412 Mhz - 2462 MHz (FCC) 2400 MHz - 2483.5 MHz (SRRC)
------------------	---

Transmitter Power (EIRP):	≤ 21.5 dBm (FCC) ≤ 20 dBm (CE/SRRC)
---------------------------	--

Protocol:	IEEE 802.11 b/g/n
-----------	-------------------

Ethernet

Socket:	RJ45
Speed:	100 Mbps / Full Duplex

Laser (CLASS 1)

Wavelength:	850 nm, 850 nm
Maximum Output of Laser Radiation	< 0.778 mW



Dystrybucja w Polsce

X3D Sp. z o.o.
ul. Zaulek Drozdowy 2 77-100 Bytów
<https://x3dshop.com/> | sklep@x3dshop.com | 530 670 568